

F05E Series Rotary Encoder

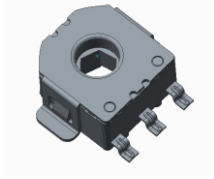

Feature

1. Miniature and highly accurate contact type encoder
2. 5mm wide and 2.7mm high excelepe
3. Incremental type

Application:

- Consumer Products

Recommended model:

- ◆ F05E-V1

Electrical Characteristics

Rated Power	DC 5V, 0.55mA(0.55mA max)
Fluttering	T1, T3 ≤ 6ms
Insulation Resistance	More than 50mΩ at 50V DC 1mA
Sliding Noise(Bounce)	T2 ≤ 6ms
Phase-Difference	ΔTR ≥ 0.08T

Mechanical Characteristics

Total Rotational Angle	360° (Endless)
Detent Torque	16 ± 13 gf.cm
Number and Position of Detent	12 Detents

Endurance Characteristics

Rotational Life	20,000 Cycles
Operating Temperature Rangs	-30°C ~ +85°C

HOW TO ORDER

F05E-	V1
Model Series	Type
V1	H1 H2

F05E-V1

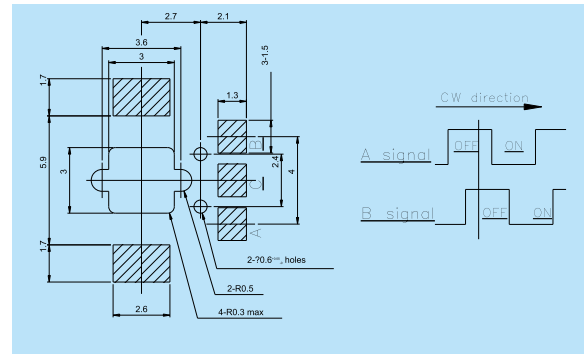
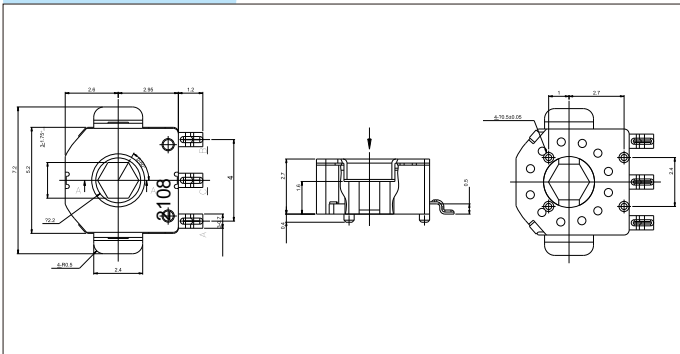

F05E-H1

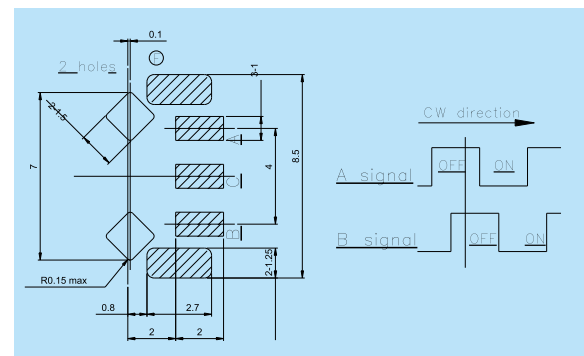
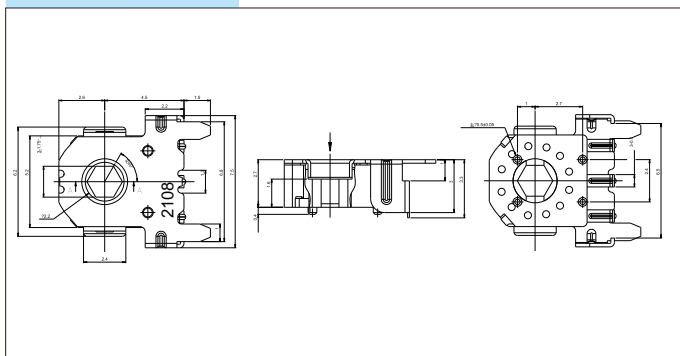

F05E-H2

